

Strata[®] ***CTX***

Digital Business Telephone Systems

DKT2104-CT
Cordless Digital Telephone
User Guide

Publication Information

Toshiba America Information Systems, Inc., Telecommunication Systems Division, reserves the right, without prior notice, to revise this information publication for any reason, including, but not limited to, utilization of new advances in the state of technical arts or to simply change the design of this document.

Further, Toshiba America Information Systems, Inc., Telecommunication Systems Division, also reserves the right, without prior notice, to make such changes in equipment design or components as engineering or manufacturing methods may warrant.

CTX-UG-D2104-VA
4016198

Version A.1, January 2002

© Copyright 2002

Toshiba America Information Systems, Inc. Telecommunication Systems Division

All rights reserved. No part of this manual, covered by the copyrights hereon, may be reproduced in any form or by any means—graphic, electronic, or mechanical, including recording, taping, photocopying, or information retrieval systems—without express written permission of the publisher of this material.

Strata is a registered trademark of Toshiba Corporation.
Strategy is a registered trademark of Toshiba America Information Systems, Inc.

Trademarks, registered trademarks, and service marks are the property of their respective owners.

TOSHIBA AMERICA INFORMATION SYSTEMS, INC. ("TAIS")

Telecommunication Systems Division License Agreement

IMPORTANT: THIS LICENSE AGREEMENT ("AGREEMENT") IS A LEGAL AGREEMENT BETWEEN YOU ("YOU") AND TAIS. CAREFULLY READ THIS LICENSE AGREEMENT. USE OF ANY SOFTWARE OR ANY RELATED INFORMATION (COLLECTIVELY, "SOFTWARE") INSTALLED ON OR SHIPPED WITH A TAIS TELECOMMUNICATION SYSTEM PRODUCT OR OTHERWISE MADE AVAILABLE TO YOU BY TAIS IN WHATEVER FORM OR MEDIA, WILL CONSTITUTE YOUR ACCEPTANCE OF THESE TERMS, UNLESS SEPARATE TERMS ARE PROVIDED BY THE SOFTWARE SUPPLIER. IF YOU DO NOT AGREE WITH THE TERMS OF THIS LICENSE AGREEMENT, DO NOT INSTALL, COPY OR USE THE SOFTWARE AND PROMPTLY RETURN IT TO THE LOCATION FROM WHICH YOU OBTAINED IT IN ACCORDANCE WITH APPLICABLE RETURN POLICIES. EXCEPT AS OTHERWISE AUTHORIZED IN WRITING BY TAIS, THIS SOFTWARE IS LICENSED FOR DISTRIBUTION ONLY TO END-USERS PURSUANT TO THIS LICENSE AGREEMENT.

- License Grant.** The Software is not sold; it is licensed upon payment of applicable charges. TAIS grants to you a personal, non-transferable and non-exclusive right to use the copy of the Software provided under this License Agreement. You agree you will not copy the Software except as necessary to use it on one TAIS system at a time at one location. Modifying, translating, renting, copying, distributing, transferring or assigning all or part of the Software, or any rights granted hereunder, to any other persons and removing any proprietary notices, labels or marks from the Software is strictly prohibited; You agree violation of such restrictions will cause irreparable harm to TAIS and provide grounds for injunctive relief, without notice, against You or any other person in possession of the Software. You and any other person whose possession of the software violates this License Agreement shall promptly surrender possession of the Software to TAIS, upon demand. Furthermore, you hereby agree not to create derivative works based on the Software. TAIS reserves the right to terminate this license and to immediately repossess the software in the event that You or any other person violates this License Agreement.
- Intellectual Property.** You acknowledge that no title to the intellectual property in the Software is transferred to you. You further acknowledge that title and full ownership rights to the Software will remain the exclusive property of TAIS and/or its suppliers, and you will not acquire any rights to the Software, except the license expressly set forth above. You will not remove or change any proprietary notices contained in or on the Software. The Software is protected under US patent, copyright, trade secret, and/or other proprietary laws, as well as international treaties. Any transfer, use, or copying of the software in violation of the License Agreement constitutes copyright infringement. You are hereby on notice that any transfer, use, or copying of the Software in violation of this License Agreement constitutes a willful infringement of copyright.
- No Reverse Engineering.** You agree that you will not attempt, and if you employ employees or engage contractors, you will use your best efforts to prevent your employees and contractors from attempting to reverse compile, reverse engineer, modify, translate or disassemble the Software in whole or in part. Any failure to comply with the above or any other terms and conditions contained herein will result in the automatic termination of this license and the reversion of the rights granted hereunder back to TAIS.
- Limited Warranty.** THE SOFTWARE IS PROVIDED "AS IS" WITHOUT WARRANTY OF ANY KIND. TO THE MAXIMUM EXTENT PERMITTED BY APPLICABLE LAW, TAIS AND ITS SUPPLIERS DISCLAIM ALL WARRANTIES WITH REGARD TO THE SOFTWARE, EITHER EXPRESS OR IMPLIED, INCLUDING, BUT NOT LIMITED TO, THE WARRANTY OF NON-INFRINGEMENT OF THIRD PARTY RIGHTS, THE WARRANTY OF YEAR 2000 COMPLIANCE, AND THE IMPLIED WARRANTIES OF MERCHANTABILITY AND FITNESS FOR A PARTICULAR PURPOSE. THE ENTIRE RISK AS TO THE QUALITY AND PERFORMANCE OF THE SOFTWARE IS WITH YOU. NEITHER TAIS NOR ITS SUPPLIERS WARRANT THAT THE FUNCTIONS CONTAINED IN THE SOFTWARE WILL MEET YOUR REQUIREMENTS OR THAT THE OPERATION OF THE SOFTWARE WILL BE UNINTERRUPTED OR ERROR-FREE. HOWEVER, TAIS WARRANTS THAT ANY MEDIA ON WHICH THE SOFTWARE IS FURNISHED IS FREE FROM DEFECTS IN MATERIAL AND WORKMANSHIP UNDER NORMAL USE FOR A PERIOD OF NINETY (90) DAYS FROM THE DATE OF DELIVERY TO YOU.
- Limitation of Liability.** TAIS' ENTIRE LIABILITY AND YOUR SOLE AND EXCLUSIVE REMEDY UNDER THIS LICENSE AGREEMENT SHALL BE AT TAIS' OPTION REPLACEMENT OF THE MEDIA OR REFUND OF THE PRICE PAID. TO THE MAXIMUM EXTENT PERMITTED BY APPLICABLE LAW, IN NO EVENT SHALL TAIS OR ITS SUPPLIERS BE LIABLE TO YOU FOR ANY CONSEQUENTIAL, SPECIAL, INCIDENTAL OR INDIRECT DAMAGES FOR PERSONAL INJURY, LOSS OF BUSINESS PROFITS, BUSINESS INTERRUPTION, LOSS OF BUSINESS INFORMATION/DATA, OR ANY OTHER PECUNIARY LOSS OF ANY KIND ARISING OUT OF THE USE OR INABILITY TO USE THE SOFTWARE, EVEN IF TAIS OR ITS SUPPLIER HAS BEEN ADVISED OF THE POSSIBILITY OF SUCH DAMAGES. IN NO EVENT SHALL TAIS OR ITS SUPPLIERS BE LIABLE FOR ANY CLAIM BY A THIRD PARTY.
- State/Jurisdiction Laws.** SOME STATES/JURISDICTIONS DO NOT ALLOW THE EXCLUSION OF IMPLIED WARRANTIES OR LIMITATIONS ON HOW LONG AN IMPLIED WARRANTY MAY LAST, OR THE EXCLUSION OR LIMITATION OF INCIDENTAL OR CONSEQUENTIAL DAMAGES, SO SUCH LIMITATIONS OR EXCLUSIONS MAY NOT APPLY TO YOU. THIS LIMITED WARRANTY GIVES YOU SPECIFIC RIGHTS AND YOU MAY ALSO HAVE OTHER RIGHTS WHICH VARY FROM STATE/JURISDICTION TO STATE/JURISDICTION.
- Export Laws.** This License Agreement involves products and/or technical data that may be controlled under the United States Export Administration Regulations and may be subject to the approval of the United States Department of Commerce prior to export. Any export, directly or indirectly, in contravention of the United States Export Administration Regulations, or any other applicable law, regulation or order, is prohibited.
- Governing Law.** This License Agreement will be governed by the laws of the State of California, United States of America, excluding its conflict of law provisions.
- United States Government Restricted Rights.** The Software is provided with Restricted Rights. Use, duplication, or disclosure by the United States Government, its agencies and/or instrumentalities is subject to restrictions as set forth in subparagraph (c)(1)(ii) of The Rights in Technical Data and Computer Software Clause at DFARS 252.227-7013 (October 1988) or subparagraphs (c)(1) and (2) of the Commercial Computer Software - Restricted Rights at 48 CFR 52.227-19, as applicable.
- Severability.** If any provision of this License Agreement shall be held to be invalid, illegal or unenforceable, the validity, legality and enforceability of the remaining provisions hereof shall not in any way be affected or impaired.
- No Waiver.** No waiver of any breach of any provision of this License Agreement shall constitute a waiver of any prior, concurrent or subsequent breach of the same or any other provisions hereof, and no waiver shall be effective unless made in writing and signed by an authorized representative of the waiving party.

YOU ACKNOWLEDGE THAT YOU HAVE READ THIS LICENSE AGREEMENT AND THAT YOU UNDERSTAND ITS PROVISIONS. YOU AGREE TO BE BOUND BY ITS TERMS AND CONDITIONS. YOU FURTHER AGREE THAT THIS LICENSE AGREEMENT CONTAINS THE COMPLETE AND EXCLUSIVE AGREEMENT BETWEEN YOU AND TAIS AND SUPERSEDES ANY PROPOSAL OR PRIOR AGREEMENT, ORAL OR WRITTEN, OR ANY OTHER COMMUNICATION RELATING TO THE SUBJECT MATTER OF THIS LICENSE AGREEMENT.

Toshiba America Information Systems, Inc.
Telecommunication Systems Division

9740 Irvine Boulevard
Irvine, California 92618-1697
United States of America

TSDD 081601

5932

Toshiba America Information Systems, Inc.

Telecommunication Systems Division

Limited Warranty

Toshiba America Information Systems, Inc., (“TAIS”) warrants that this voice processing equipment (except for fuses, lamps, and other consumables) will, upon delivery by TAIS or an authorized TAIS dealer to a retail customer in new condition, be free from defects in material and workmanship for twenty-four (24) months after delivery. This warranty is void (a) if the equipment is used under other than normal use and maintenance conditions, (b) if the equipment is modified or altered, unless the modification or alteration is expressly authorized by TAIS, (c) if the equipment is subject to abuse, neglect, lightning, electrical fault, or accident, (d) if the equipment is repaired by someone other than TAIS or an authorized TAIS dealer, (e) if the equipment’s serial number is defaced or missing, or (f) if the equipment is installed or used in combination or in assembly with products not supplied by TAIS and which are not compatible or are of inferior quality, design, or performance.

The sole obligation of TAIS or Toshiba Corporation under this warranty, or under any other legal obligation with respect to the equipment, is the repair or replacement by TAIS or its authorized dealer of such defective or missing parts as are causing the malfunction with new or refurbished parts (at their option). If TAIS or one of its authorized dealers does not replace or repair such parts, the retail customer’s sole remedy will be a refund of the price charged by TAIS to its dealers for such parts as are proven to be defective, and which are returned to TAIS through one of its authorized dealers within the warranty period and no later than thirty (30) days after such malfunction, whichever first occurs.

Under no circumstances will the retail customer or any user or dealer or other person be entitled to any direct, special, indirect, consequential, or exemplary damages, for breach of contract, tort, or otherwise. Under no circumstances will any such person be entitled to any sum greater than the purchase price paid for the item of equipment that is malfunctioning.

To obtain service under this warranty, the retail customer must bring the malfunction of the machine to the attention of one of TAIS’ authorized dealers within the twenty-four (24) month period and no later than thirty (30) days after such malfunction, whichever first occurs. Failure to bring the malfunction to the attention of an authorized TAIS dealer within the prescribed time results in the customer being not entitled to warranty service.

THERE ARE NO OTHER WARRANTIES FROM EITHER TOSHIBA AMERICA INFORMATION SYSTEMS, INC., OR TOSHIBA CORPORATION WHICH EXTEND BEYOND THE FACE OF THIS WARRANTY. ALL OTHER WARRANTIES, EXPRESS OR IMPLIED, INCLUDING THE WARRANTIES OF MERCHANTABILITY, FITNESS FOR A PARTICULAR PURPOSE, AND FITNESS FOR USE, ARE EXCLUDED.

No TAIS dealer and no person other than an officer of TAIS may extend or modify this warranty. No such modification or extension is effective unless it is in writing and signed by the vice president and general manager, Telecommunication Systems Division.

Contents

Introduction

Organization.....	v
Conventions	vi
Related Documents and Media	vi

Chapter 1 – The Grand Tour

Digital Technology	2
Handset	2
Base Unit.....	4
Charger Unit.....	4
Batteries	4
Volume Levels	5
Handset Mute	6
Cordless Digital Telephone Standard Parts	6

Chapter 2 – Installation

Base Unit	12
Charger Unit	12

Chapter 3 – Configuration

Enter the Program Mode	15
------------------------------	----

Chapter 4 – Handset Operation

Switching Cordless and DKT Modes	18
Tone or Voice First Signaling.....	18

Contents

Chapter 5 – Features

Handset Volume.....	19
Ringer Volume.....	19
Mute	19
Important - Read First.....	20
What's My Line?.....	20
Making a Call.....	20
Internal Numbers	20
External Numbers	21
Answering Calls.....	21
CO Lines or [DNs]	21
Pooled Line Groups.....	21
Transferred Calls	21
Recalling Busy Stations	21
Using Busy Override.....	22
Calling the Attendant Console	22
Using ISDN Trunks	22
Transferring Calls	23
Answering a Transferred Call.....	23
Transfer Calls to the Cordless.....	24
Transfer Calls to the DKT	24
Using Camp-on.....	24
Conference Calls	25
Adding Voice Mail to a Conference.....	26
Connecting Two Outside Lines	26

Chapter 5 – Features

Account Code Calls	28
Verified/Non-Verified Account Codes.....	28
Forced Account Codes.....	28
Voluntary Account Codes (Verified/Non-Verified).....	29
Automatic Busy Redial	29
Automatic Callback	30
Auto Redial	31
Call Forward	31
System.....	31

Station	31
Call Forward Categories	32
Call Forward Settings	32
Call Park Orbits.....	36
Group Pickup	37
Page/Internal Call Pickup	37
Call Waiting	39
Direct Station Selection Buttons (Hotline)	39
Do Not Disturb.....	40
Setting DND for Another Extension.....	40
Door Lock(s).....	41
Door Phone(s)	42
Emergency Ringdown.....	43
Held Calls.....	43
Placing Line Appearances or [DN] Calls on Hold	44
Retrieving Held Calls	44
Using Automatic Hold.....	44
Switching Between Calls.....	44
ISDN Outgoing Calling	45
Subaddress	45
Message Waiting.....	45
Responding to a Lit Msg LED	46
Off-hook Call Announce.....	46
Override Calls	47
Busy Override.....	47
Do Not Disturb Override	47
Executive Override	48
Privacy Override.....	48
Paging	48
Answering a Page	49
All Call Page.....	49
Emergency Page	49
Privacy	50
Redial	50
Release and Answer.....	51

Contents

Chapter 5 – Features

Speed Dial.....	51
Make a Call Using Speed Dial.....	51
Tone/Pulse Dialing.....	52
Voice Mail - Direct Transfer.....	52

Appendix A – Appendix – Feature Access

Codes	53
--------------------	----

Appendix B – Appendix – Troubleshooting and Specifications

Troubleshooting	59
Range and Performance	61
Simultaneous Conversation Channels.....	61
Radio Interference.....	61
Specifications.....	62
Index	63

Introduction

This guide describes the features and operation of the Strata DK DKT2104-CT 900 MHz Cordless Digital Telephone with Strata CTX Business Telephone Systems. To get the most from your cordless telephone, please read this guide thoroughly.

The DKT2104-CT also works with Strata DK telephone systems (except Strata DK24/56/96, Release 3). Refer to the appropriate user guide for your telephone system (see [“Related Documents and Media” on page vi](#)).

Organization

This user guide is divided as follows:

- **Chapter 1 – The Grand Tour** is an equipment overview of the handset and batteries, Base and Charger Units.
- **Chapter 2 – Installation** has step-by-step installation instructions.
- **Chapter 3 – Configuration** covers optimizing the performance of your cordless telephone, using configuration options.
- **Chapter 4 – Handset Operation** covers operating controls and features.
- **Chapter 5 – Features** covers the practical operation of the cordless features.
- **Appendix A - Feature Access Codes** includes codes used for specific feature access.
- **Appendix B - Troubleshooting and Specifications** covers troubleshooting, range and performance, simultaneous conversation channels, radio interference, specifications, and access codes.

Conventions

Conventions	Description
Note	Elaborates specific items or references other information. Within some tables, general notes apply to the entire table and numbered notes apply to specific items.
Important!	<i>Calls attention to important instructions or information.</i>
WARNING!	Alerts you when the given task could cause personal injury or death.
Arial Bold	Represents telephone buttons.
Courier	Shows a computer keyboard entry or screen display.
Tilde (~)	Means “through.” Example: 350 ~ 640 Hz frequency range.
➤	Denotes the step in a one-step procedure.
➤	Denotes a procedure.
See Figure 10	Grey words within the printed text denote cross-references. In the electronic version of this document (Library CD-ROM or FYI Internet download), cross-references appear in blue hypertext.

Related Documents and Media

Note Some documents listed here may appear in different versions on the CD-ROM or in print. To find the most current version, check the version/date in the Publication Information on the back of the document’s title page.

The following CD-ROM can be used to reference further information about the Strata CTX systems.

- Strata CTX WinAdmin Application Software and Documentation Library

For DKT2104-CTs connected to a Strata DK14, DK16e, DK16, DK24/56/96 (Release 4.0), DK40i, DK40, DK280 (Release 3.0 or higher), DK424i, DK424, refer to:

- Strata DK DKT2104-CT Cordless Digital Telephone User Guide

This chapter familiarizes you with the Strata CTX DKT2104-CT Cordless Digital Telephone handset and its batteries, Base and Charger Units, and fixed buttons. [Chapter 5 – Features](#), beginning on [page 27](#) covers the four pre-assigned flexible buttons.

The DKT2104-CT brings mobility and productivity to office telephones. It cuts down on “telephone tag” delays and is easy to take with you. It works with Strata CTX and Strata DK telephone systems (except Strata DK24/56/96, Release 3) and provides you with reliability, long life, and outstanding performance. Some of its features are:

- Liquid Crystal Display (LCD) that wraps using 2 lines, total of 32 characters
- Four displayed operation modes, including Message Waiting (MW)
- HOLD, MSG (with MSG LED), CNF/TRN, and MUTE buttons
- Wall-mount plate, belt clip, and two batteries
- Two handset volumes, four ring levels, and a vibration mode
- Simultaneous charging of handset and spare batteries
- Wall-mount or desktop unit
- Stand-alone or DKT operation

Digital Technology

The DKT2104-CT uses 900 MHz Digital Narrow Band technology that provides:

- Unsurpassed range, two to three times greater than conventional analog cordless telephones.
- Clarity that is so good, it is indistinguishable from corded telephones in most environments.
- Maximum security for up to 30 cordless digital telephones that is almost impossible to scan.

Handset

Your cordless handset has special function buttons (shown at right) and an LCD that shows operating conditions.

The LCD displays “talk” when the battery is hot swapped (quickly removed and returned to the handset while talking). “Message” displays in standby mode only.

There is a ringer on the side of the handset that toggles the ringer/vibrator On and Off.

[Table 1](#) describes the available buttons and [Table 2](#) describes the LCD messages.

Note Though highly unlikely, it is possible for two cordless telephones to share the same channel. If this occurs, the DKT2104-CT will automatically switch to a clear channel within five seconds.

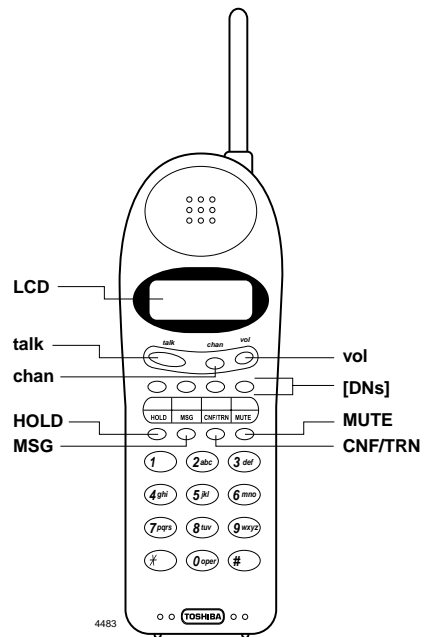

Table 1 Button Description

Button	Description
talk	Initiates and disconnects calls.
vol	Selects ringer tone and volume in standby mode and speaker volume in talk mode.
chan	Selects channel while in talk mode and locks the handset while in standby mode.
HOLD	Places calls on hold.
MSG	Sets MW indication at called station.
CNF/TRN	Conferences and transfers calls.
MUTE	Toggles the mute feature On and Off (mutes your conversation away from the handset).

Table 2 LCD Messages

LCD Message	Action	Corresponding LED
<i>talk</i>	Changing channels	Blinks at 300 msec. (On and Off).
	Muted	Blinks at 600 msec. (On and Off).
	Transferring	Blinks at 200 msec. (On and Off).
	Transferring and muted	Blinks at 200 msec. (On and Off), then 200 msec. On and 600 msec. Off.
	Reconnecting to a call	Steady
<i>lowbatt</i>		Steady
<i>lock</i>	Turning On	Steady
	Setting up	Off
	Canceling	Steady
<i>message</i>	Retrieving	Steady

Base Unit

The Base Unit can be used as a desktop or wall-mounted unit (shown at right). There are two LEDs that indicate Desk or Cordless mode.

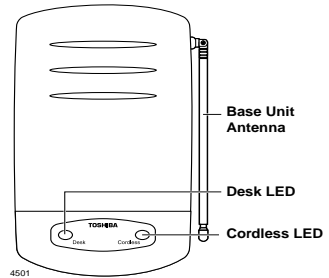

Charger Unit

The handset comes with a Charger Unit (shown at right) that has front and rear slots.

The front slot functions as a cradle for the handset when idle and a charger for the handset battery.

The rear slot is for spare battery charging. It automatically discharges when it detects that discharging is necessary.

Charge 1 and 2 LEDs indicate battery charging status. The LEDs flash red when charging, and are steady red when the battery is charged.

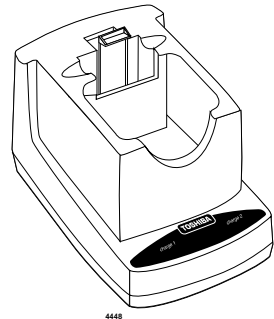

Batteries

Your cordless telephone comes equipped with two Sealed Lead Acid batteries that provide 5 hours of talk and 40 hours of standby time (fully charged). A “fast charge” in the handset and a “trickle charge” in the Charger Unit enables the extended talk and standby times.

When the battery is low, the message at the right displays on the LCD and the handset beeps. Low battery symptoms are:



- On a call
 - Only **talk** operates
 - Handset beeps once every three seconds
- In standby mode
 - None of the buttons operate
 - Handset beeps once
 - Cannot make call

CAUTION! Do not completely discharge the battery. The Lead-Acid battery for the DK2104-CT is similar to your car battery and can be damaged if it is completely discharged.

Make sure your spare battery is always charging to ensure against complete battery discharge. To restore your battery capacity, return the handset to the Charger Unit for charging or replace the handset battery with a charged one. The batteries can remain in the Charger Unit for over one month. For more information on installing and charging the battery, see [“Install Handset Battery”](#) on [page 13](#).

Volume Levels

Your handset has a volume (**vol**) button just below the LCD that changes the ringer type and the volume for the selected type. There are three available types – Type A (two volume levels), Type B (two volume levels) and Vibrator (On/Off). When the handset is idle, press **vol** to select ring type and volume. You also have a toggle switch on the handset (left-hand side) that mutes the ringer.

Handset Mute

Your handset speaker can be muted to consult another person in the room without the caller hearing you. The mute feature is easily turned On and Off by pressing the button.

Cordless Digital Telephone Standard Parts

Your Toshiba cordless digital telephone includes the following items:

- Base Unit
- Handset
- Telephone Cord (2 ft.)
- AC Adapter
- Rechargeable Batteries (2)
- Belt Clip
- Wall Mount
- Charger Base
- User Guide

If any of these items are missing or damaged, contact your System Administrator.

Important! *Your telephone system must be programmed for Auto Preference before **talk** operates. If there is a shared DKT, you receive system dial tone automatically after picking up the DKT handset. See your System Administrator for more information.*

Step 1: Review Safety Instructions

WARNING! To reduce the risk of fire and/or personal injury by the battery, follow these instructions:

- Read and understand all product instructions.
- Follow all warnings and instructions marked on the product.
- Cleaning precautions:
 - Unplug this product from the wall outlet before cleaning.
 - Do not use liquid cleaners or aerosol cleaners.
 - Use a dry cloth for cleaning.
- Do not use this product near water; for example, near a sink, or in any wet area.
- Never spill liquid of any kind on the product.
- Do not place this product on an unstable cart, stand, or table. The telephone could fall, causing serious damage to the unit.

Installation

Step 1: Review Safety Instructions

- To protect the product from overheating, do not:
 - Block or cover any slots or openings in the Base Unit
 - Place near or over a radiator or heat register
 - Place in an enclosed cabinet unless proper ventilation is provided.
- Operate this product only from the type of power source indicated on the marking label.
- Do not allow anything to rest on the power cord. Do not locate this product where the cord could be damaged by persons walking on it.
- Do not overload wall outlets and extension cords because it could result in fire or electrical shock.
- Never push objects of any kind into the Base Unit slots, as the objects could touch dangerous voltage points or short out parts that could cause fire or electric shock.
- To reduce the risk of electric shock, do not disassemble this product. Opening or removing covers could expose you to dangerous voltages or other risks. Incorrect re-assembly can cause electric shock when the appliance is subsequently used. Contact qualified service personnel when service or repair work is required.
- Unplug this product from the wall outlet and refer servicing to qualified service personnel under the following conditions:
 - When the power supply cord is damaged or frayed.
 - If liquid has been spilled into the product.
 - If the product has been exposed to rain or water.
 - If the product does not operate normally when following the operating instructions. Adjust only those controls that are covered by the operating instructions. Improper adjustment of other controls may result in damage, and will often require extensive work by a qualified technician to restore the product to normal operation.
 - If the product has been dropped, or the cabinet has been damaged.
 - If the product exhibits a distinct change in performance.
 - Do not use the telephone to report a gas leak in the vicinity of the leak.

WARNING! To reduce the risk of fire and/or personal injury by the battery, follow these instructions:

- Use only battery model BT-9000. Use of any other battery could cause a safety hazard.
- Do not dispose of the battery in a fire. The cell will explode. Under federal, state and local laws, it could be illegal to dispose of old batteries by placing them in the trash. Check with your local government for information on where to recycle or dispose of old batteries. If you cannot find the information you need, contact Toshiba for assistance.
- Do not open or mutilate the battery. Released electrolyte is corrosive and causes damage to the eyes or skin, and, if swallowed, is toxic. Sealed Lead Acid is a chemical known to the State of California to cause cancer.
- Exercise care in handling the battery in order not to short the battery with rings, bracelets, and keys or other conductive materials. The battery or conductor could overheat and cause burns.
- Charge the battery only in accordance with the instructions and limitations specified in the instruction manual provided for this product.
- Observe proper polarity orientation between the battery and Charger Unit.

Installation

Step 2: Select Location

Step 2: Select Location

1. Select a location that is not subject to excessive heat or humidity.
2. Determine if the Base Unit will sit on your desk or be wall mounted. If wall mounted, go to [Step 3: “Mount on a Wall”](#).
3. Place the Base Unit on a desk or tabletop near a standard 120VAC outlet and within reach of the Strata CTX digital line connection.
4. Keep the Base Unit and handset away from sources of electrical noise, such as motors and fluorescent lighting.

Important! *Place the Base Unit to the right of the DKT. If placed on the left, the cordless antenna picks up a tone due to its close proximity to the DKT speaker and electronic parts.*

Step 3: Mount on a Wall

1. Select a wall location near a 120VAC outlet and within reach of the Strata CTX digital line connection.
2. Place the wall plate (shown at right) against the wall, and with a pencil, mark the position of the screws.
3. With a punch tool, punch “starter” holes in the wall.
4. Align the wall plate and screws on the wall where the “starter” holes are and tighten down the screws.

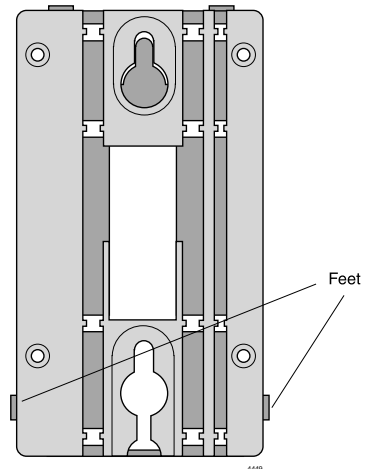

5. Ensure that the wall-mount plate is placed on the wall so that the “feet” are at the bottom when you are looking at the inside of the plate.
6. Snap the Base Unit onto the plate (shown above).

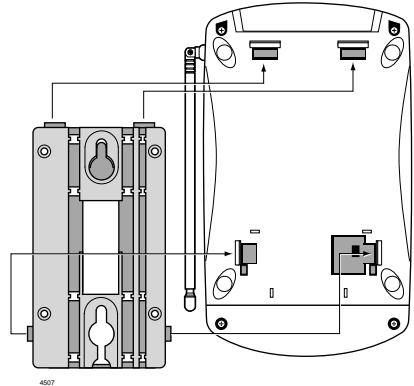

Step 4: Connect Telephone Cables

► To connect as a stand-alone telephone

- Connect the modular jack labeled “Line In” directly to the telephone wall jack using one of the supplied cables (shown at right).

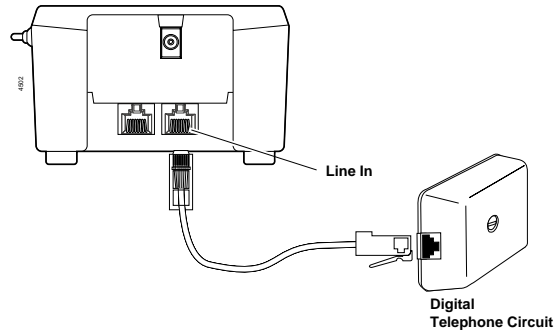

► To connect to a Strata DKT

1. Unplug the cable from the DKT and plug into the “Line In” jack of cordless telephone Base Unit (shown at right).
2. Plug the additional two-foot cable into the “Line Out” jack of the Base Unit and into the DKT jack located on the bottom of the telephone.

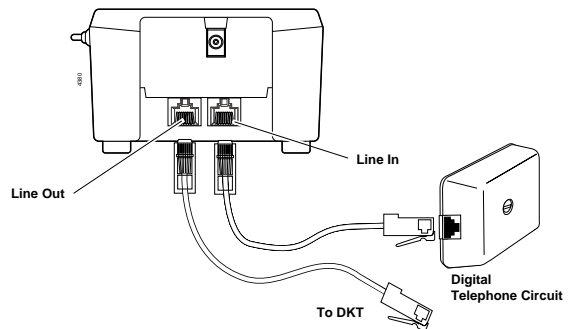

Step 5: Connect and Apply Power

Base Unit

1. Plug the AC adapter cord into the AC adapter input jack on the Base Unit (shown at right).
2. Plug the AC adapter into a standard 120VAC wall outlet.
3. Check to see that the power LED is on.

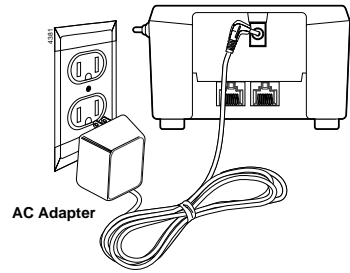

Charger Unit

1. Plug the AC adapter cord into the input jack on the Charger Unit (shown at right).
2. Plug the AC adapter into a standard 120VAC wall outlet.
3. Check to see that the power LED is on.

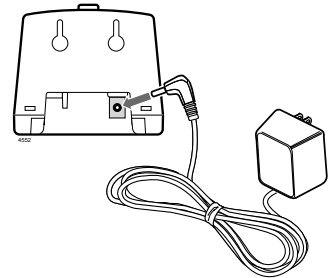

Important!

- *If the power does not light on either the Charger or Base Units, return everything to your Authorized Dealer.*
- *Always route the power cord where it is not a trip hazard, and where it cannot become chafed and create a fire or electrical hazard.*

Step 6: Raise the Base Unit Antenna

- Before using your handset, raise the Base Unit antenna to the vertical position.

Step 7: Install Handset Battery

Note Your handset should come from the factory with one battery already installed and charged. If not, follow steps below and see [Step 8: Charge Batteries for First Time](#).

1. Carefully remove the battery cover from the back of the handset (shown at right).
2. Place a charged battery into the handset so that it slides easily along the ridges, ensuring that the polarity is correct (minus to minus and positive to positive). The battery clicks into place.
3. Carefully slide the battery cover onto the back of the handset.

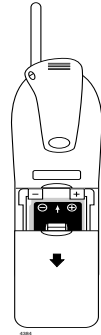

Step 8: Charge Batteries for First Time

Important! *Before using your handset, the battery must be continuously charged for 10 hours.*

1. Place the handset in the Charger Unit (shown at right).
2. Ensure that charge 1 LED lights. If it does not, make sure that the AC adapter is plugged in and that the handset is making good contact with the Charger Unit.
3. Slide the spare battery in the rear slot of the Charger Unit (shown at right) until it clicks into place.
4. Make sure that the top (marked with plus and minus signs) faces down toward the bottom of the Charger Unit.
5. Ensure that charge 2 LED lights. If it does not, make sure that the AC adapter is plugged in and that the handset is making good contact with the Charger Unit.

Now you are ready to configure your cordless handset. See [Chapter 3 – Configuration](#), beginning on [page 15](#) for more information.

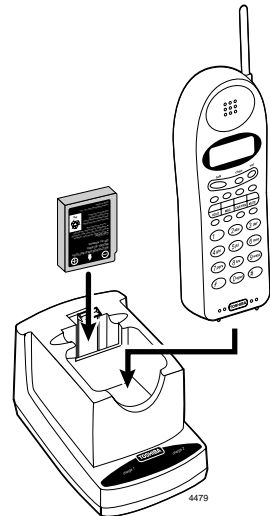

Installation

Step 9: Install Headset (Optional)

Step 9: Install Headset (Optional)

The optional headset provides a hands-free option because you can use the belt clip to carry the handset and conduct a conversation. All feature operations remain the same except the handset earphone and microphone are disconnected.

- Open the cover over the headset jack that is located on the side of the handset and plug in the headset as shown at right..

Important! *Only use headsets especially designed or modified for use with radio frequency equipment.*

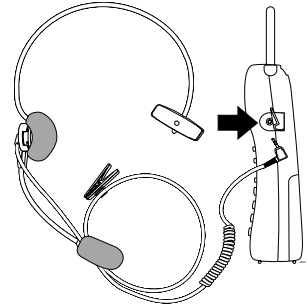

Step 10: Install Belt Clip

Note The belt clip is designed to fit snugly onto the handset.

1. Remove the belt clip tab from the top rear of the handset (shown at right).
2. Slide the belt clip into the space where the belt clip tab was, carefully aligning the belt clip sides to the notches.
3. Use the belt clip to attach the handset to your belt or pocket.

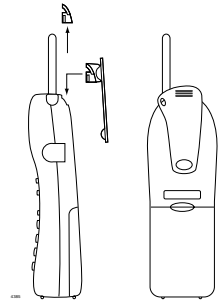

➤ To remove the belt clip

1. Pull the belt clip release button back (shown at right).
2. Carefully lift the belt clip off.

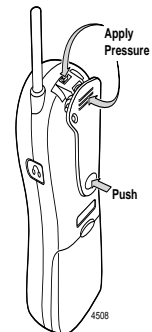

This chapter shows you how to configure the DKT2104-CT. It can operate as a DKT or cordless telephone and be programmed whenever it is idle. When entering the program mode, all incoming calls are identified with a ringback tone until the program mode is ended and current calls are unaffected.

You can configure three settings that affect the way the cordless telephone operates with the Strata CTX system that are:

- PROG1 – reserved
- PROG2 – reserved
- RCV LEVEL – F3 (On) sets the receive level to normal; F3 (Off) sets the receive level to 4-dB level (level).

These settings default to On.

Enter the Program Mode

1. Remove the handset from the Charger Unit.
2. Press and hold * and # at the same time (shown at right).
3. Press **vol** to step forward and back through the menu.

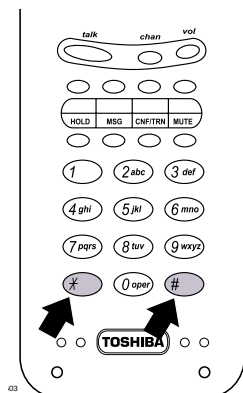

Configuration

Enter the Program Mode

4. While holding * and #, press **talk** (shown at right).
5. Release *, #, and **talk** simultaneously.
6. Press **chan** until **data store** displays.
7. Press **0** to toggle the settings for each program step
...or store the setting when in the **data store** step.
8. Press **talk** at any time to exit without saving changes
...or save the changes by stepping to **data store** and
pressing **0** before **talk**.

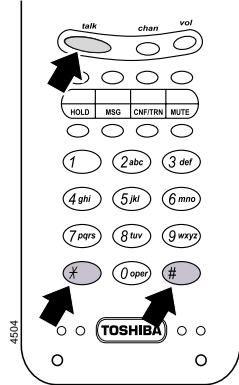

Note The F3 LED changes for each of the program steps after **0** is pressed.

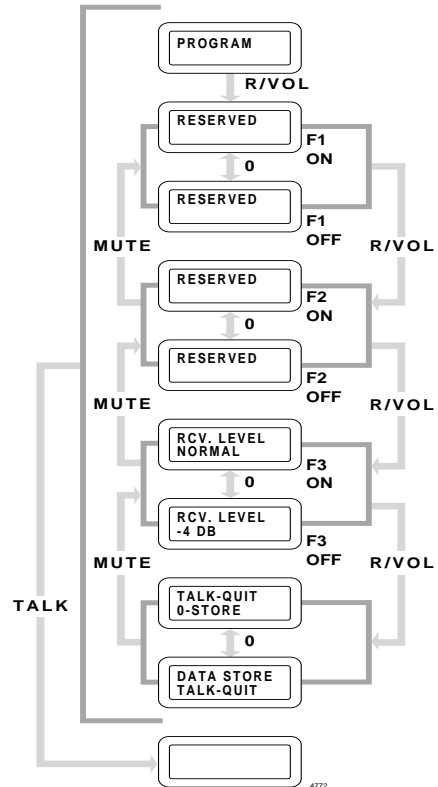

This chapter familiarizes you with basic handset operation, including:

- Switching cordless and DKT modes
- Signaling
- Controlling handset and ringer volume
- Making and answering calls
- Calling busy stations and attendant consoles
- Using CO access codes
- Using ISDN trunks
- Transferring and conferencing calls

Your cordless telephone is easy to use and has a lightweight handset. The LCD gives you up-to-the minute status on transmission and call processing. If the LCD is blank, the handset is in standby mode and ready to use.

Note The LCD displays **no service** when you are out of range, and you have 20 seconds to move back into range.

Switching Cordless and DKT Modes

➤ To set the cordless mode

1. Pick up the handset and press **talk**. This message blinks, and you hear dial tone.

The Cordless LCD shows **ACQUIRING LINK**. The DKT displays **CORDLESS MODE**.

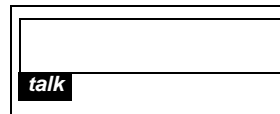

2. Press **talk** again and return the handset to the Charger Unit. This displays on the handset and the DKT LCD.

Note The handset LCD goes blank after a few seconds.

...or clip it to your belt.

➤ To set DKT mode

- Pick up the DKT telephone. You hear dial tone. This displays on the handset and the DKT LCD.

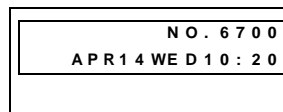

Tone or Voice First Signaling

If you are a new user of the cordless digital telephone, ask your System Administrator if the Strata CTX system has Tone or Voice First Signaling. Tone Signaling rings and Voice First has a long tone followed by the caller's voice. You can toggle between Tone and Voice First Signaling on a call-by-call basis.

Both signals are enabled in system programming and determine how you make and answer calls.

➤ To change the signaling

1. Press [DN] + station [DN]. If Tone First Signaling is enabled, you hear a one-second ring every four seconds. If Voice First Signal is enabled, you hear a tone burst.
2. Press **2**. The other signaling is activated.

➤ To answer a Tone First Signaling call

- Press **talk**. You hear successive ring tones.

Handset Volume

- Press **vol** while on a call to select a loud or soft volume level.

Ringer Volume

- Press **vol** to select the ring volume. You can choose high, low, and off for two ringer types.

Note When *ring off* displays, you receive a vibration alert instead of the audible ring tone.

Mute

- **To Mute Your Conversation**

1. Press and hold **MUTE** to consult with another person in the room without the caller hearing you.
2. Release **MUTE** to continue the conversation.

- **To Mute the Ringer**

- Press the sliding button on the side of the handset to the Off position.

Important - Read First

Be sure to check with your CTX System Administrator and make sure you know which features are enabled on your system. Use the check boxes throughout this book to mark which features you have.

What's My Line?

Throughout this guide, the word “Line” is mentioned. For example, you will be instructed to “select a Line.” “Line” can be:

- Line button
- Pooled Line Group button
- Group Line button
- Line out requiring an access code - where you enter an outside line or line group access code (for example, dialing **9** to get an outside line).

Check mark which Line type you have, then use that selection when instructed to “select a Line.”

Making a Call

Internal Numbers

1. Press **talk** or a [DN]. You hear dial tone and the LED lights steady.
2. Dial a [DN].

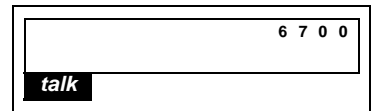

Notes

- If you have Voice First Signaling, make a voice announcement when you hear a single tone.
- If you have Tone Signaling, you hear repeated ring tones. Wait for the call to be answered.
- If the called station does not answer, you can leave a message by pressing **MSG** or **7**.

External Numbers

1. Press **talk**. You hear dial tone and LED lights steady. A line may be automatically selected or you can manually choose a line.
2. Enter a telephone number. Dial tone stops after you dial the first digit.
3. Press **talk** to hang up.

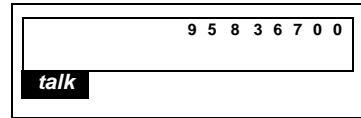

Answering Calls

CO Lines or [DNs]

- Press the flashing [DN], **Line**, or **talk**. The LED changes from flashing (incoming call rate) to steady.

Pooled Line Groups

- Press the flashing **Pooled Line Grp** or **talk**.

The LED changes from the flashing (incoming call rate) to steady.

Transferred Calls

- Press **talk**

...or the flashing [DN]. You hear ringing tone. The handset continues to ring whether the DKT is set for Voice First or Tone Signaling. The [DN] or Line LED lights steady when you connect.

Recalling Busy Stations

- Press **4** to set Automatic Call Back (ACB).

Using Busy Override

- Press **2**

Busy Override is activated (use only if the called station is not equipped for OCA).

...or **3**. Executive Override (system programmable option) is activated.

Calling the Attendant Console

There are three ways to call the Attendant Console depending upon system programming. You can call any Attendant Console, a particular Attendant Console, or all Attendant Consoles.

- **To Call Any Console**

- Press a [DN] + 0. The call rings the Attendant Console. Dial 0 calls rotate between the consoles if more than one console is installed.

- **To Call a Specific Console**

- Press a [DN] + the console's [DN] _____. The call rings the console **In-DN**.

Note Your System Administrator can provide the Attendant Console [DNs].

- **To Make an Emergency Call to All Consoles**

- Press [DN] + #911. The call rings all consoles Emgr.

Using ISDN Trunks

1. Access an outside CO line.
2. Enter a number.
3. Press **Start**.

The dialed digits are not sent until you press **Start** or the timer expires. See [“ISDN Outgoing Calling”](#) on [page 45](#) for more information on ISDN calls.

Transferring Calls

You can transfer calls to a idle or busy station, but you cannot transfer calls to a station that is in the DND mode.

Note You cannot transfer calls to a station that is DND.

1. Press **CNF/TRN**. You hear dial tone and the Line or [DN] LED flashes at the conference rate.
2. Enter the transfer-to [DN], Hunt Group [DN], or ACD group [DN]. You hear a single tone, unless the call was made with Tone First Signaling. Then, you hear ringing tone.
3. Announce the call. The Line LED changes to steady red when the called station connects with the transferred call. If the called station does not answer, you receive a recall ring. Your station or [DN] must be idle to receive the recall.
...or press **Line**, [DN] + **42** to reconnect to the transferred call before the called party answers or busy tone is received. After you hang up, the Line LED begins an on-hold flash, or the [DN] LED goes out if you transferred the call from a [DN].
4. Press **talk**. The Line LED changes to steady when the called station connects with the transferred call.

Answering a Transferred Call

► Press **talk**

...or the flashing [DN]. The [DN] or Line LED is steady when you connect to the call.

► **To transfer a call directly to Voice Mail (VM)**

1. While on a call, press **CNF/TRN**.
2. Enter **#407**.
3. Enter the VM mailbox number (usually the same as the extension number) + **#**.
4. Hang up and the caller is connected to the VM mailbox. This feature does a blind transfer to VM.

Transfer Calls to the Cordless

You can transfer an active call from the DKT to the cordless or vice versa by using **HOLD**. If the cordless is idle, the transfer takes place immediately.

1. While in conversation, press **HOLD** on the DKT. The Line LED flashes.
2. Press **talk** on the Cordless handset. The Cordless LED lights steady. The DKT LEDs go out and displays “CORDLESS MODE.”.
3. Press **HOLD** on the Cordless handset (shown right).

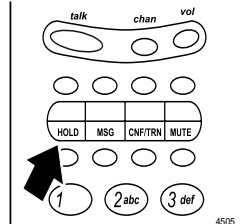

Transfer Calls to the DKT

1. Press **HOLD** on the cordless handset.
2. Pick up the DKT telephone and press the flashing Line LED.

Using Camp-on

1. Press **CNF/TRN**. You hear dial tone and the Line or [DN] LED flashes at the conference rate.
2. Enter the destination [DN], Hunt Group number, or ACD group [DN]. You hear a single tone.

Note If the call was made with Tone Signaling instead of Voice First Signaling, you hear ringing tone.

3. When the [DN] answers, announce the call. If the called station does not answer, you receive a recall ring (when your station or [DN] is idle). The ring is set by system programming.
4. Press **talk**. The Line LED changes to steady when the called station connects with the transferred call.

...or **Line**, [DN] + **42** to reconnect to the transferred line before the call is answered or busy tone is received.

The Line LED changes to steady red when the called station connects with the transferred call. After you hang up, the Line LED begins to flash at the on-hold rate or if you transferred the call from a [DN], the [DN] LED goes out. The CO Line or [DN] camps onto the called station and the called station receives a warning tone.

You receive a recall ring when your station or [DN] is idle and camp-on is cancelled when the called station user fails to answer within a predetermined time. Repeat the procedure if necessary.

Conference Calls

You can conference together up to eight parties (including your own) - with up to six parties being external CO or network lines. The actual number of conference parties with acceptable volume levels depends on the local and far end phone line conditions. The person who initiates the conference call is the Master. If, after the conference is established and the Master exits the conference, the first station to have been added to the conference becomes the Master.

► To conference calls

1. While on a call, press **CNF/TRN**. You hear dial tone. The Line LED flashes green.
2. Call another station or outside line.
3. When the called party answers, press **CNF/TRN**. If you receive a busy tone or no answer, press **CNF/TRN** again to return to the original connection. All parties are conferenced. If the second call was placed on a **Line** that appears on your phone, the LED also flashes green.
4. Repeat the above steps to add lines to the conference. Keep in mind the maximum number of allowed conference parties.

Note When the “master” of the conference hangs up, the control is automatically transferred to the first internal station added to the conference call. If no other internal stations are included in the conference call, the call is disconnected.

► To transfer conference control

1. Do Steps 1 and 2 above to add the line to which you wish to transfer conference control. See previous Note.
2. Announce the call and hang up to transfer the call. This station now becomes the conference “master” with the ability to add or delete parties.

► To hold a conference call

- If you are the Conference Master, press the **Hold** key once (or twice for Executive Hold) to place the conference call on hold. The other parties can continue with the conference. Music-on-hold is suppressed and your extension LED flashes green. You can rejoin the conference at any time by pressing your extension LED. When you return, you retain Master status.

Adding Voice Mail to a Conference

The Conference Master can add voice mail to a conference. This enables participants in a conference to listen to or leave a voice mail message during one phone call.

► **To add Voice Mail to a conference call (performed by Conference Master)**

1. Press **CNF/TRN** to place the current call on Consultation Hold.
2. Dial the voice mail (VM) extension number, then enter the VM mailbox and security code. This adds the voice mailbox to the conference.
3. Press **CNF/TRN** to reconnect to the original party. (You can continue to add conference members by pressing **CNF/TRN** and dialing another extension.)

Now, all parties in the conference can listen to or record a message to this voice mailbox. Only the Master can control the VM with touchtones or Soft Keys.

Connecting Two Outside Lines

1. While talking on an outside call, press **CNF/TRN**. You hear dial tone. The extension LED flashes (conference rate).
2. Dial an outside line access code and outside phone number.
3. After the party answers, press **CNF/TRN**. The extension LED flashes (in-use rate) and all parties are conferenced.

If you receive a busy tone or if the station does not answer, press the flashing extension button to return to the original connection, press **CNF/TRN**.

4. Hang up. The extension LED flashes (exclusive-hold rate) and the two lines are connected. The LED turns Off when the parties hang-up.
5. To supervise a tandem call, press the extension button. If the parties have finished, hang up or if the parties are still talking, press **CNF/TRN** and hang-up. Both Line LEDs turn Off and the connection is released.

If your phone company provides auto disconnect, the connection may release automatically when the parties hang up. If not, the lines must be supervised to be disconnected.

This chapter is alphabetical list of features that work with your cordless telephone. It has many of the same features as a 2000-series digital telephone. In addition to **MSG**, **HOLD**, **CONF/TRN**, and **MUTE**, you have four additional “flexible” buttons for features such as:

- Account Code
- Auto Call Back (ACB)
- Call Forward (CF) (all modes)
- Do Not Disturb (DND)
- Message Waiting (MW)
- Park in Orbit and Park and Page
- Speed Dial (SD)
- Privacy on Line and Release

The four flexible buttons perform the same way as the first four buttons on your 3000- or 2000-series digital telephone. They are assigned during system installation. See your System Administrator for the features that have been assigned. If you are not using these buttons for the assigned features, you can invoke the features with access codes.

Please see [Table 5 on page 53](#) for access code sequences that match your Toshiba telephone system.

Important! *There are some feature operation differences and limitations from the previous cordless telephone version, DKT2004-CT, that are described under the affected feature.*

Account Code Calls

Account Codes (Forced or Voluntary) can be used for a variety of reasons including billing, tracking, and line restriction applications. Account Codes are assigned in the system as a fixed length (default is six digits) and are recorded by the system, along with the details of the calls, which can be printed on a Station Message Detail Recording (SMDR) report.

Verified/Non-Verified Account Codes

If programmed for Verified Account Codes, the system checks the account code you entered against a list created by the CTX System Administrator. The code you enter must be on the list for the call to proceed. Non-verified account codes must be of a uniform length specified by the CTX System Administrator.

Forced Account Codes

Some applications require you to enter an Account Code. These Forced Account Codes may be verified or non-verified, depending upon the application, but in either case, the caller must enter a code before proceeding.

► To dial using Forced Account Codes

1. Place a call in the normal method.

If the call requires an Account Code, a burst of tone (Success Tone) is heard after dialing the telephone number alerting you to enter the Account Code.

2. Enter the account number.

When the number of digits designated for account codes has been entered, the number will be checked against the verified list, if chosen, and the call will continue as normal. If the number of digits entered for the account code is not reached or the verified code does not match, then re-order tone is heard and the call is rejected.

You can bypass Forced Account Code requirements with three emergency numbers, including 911. See your CTX System Administrator for these numbers:

- 1) 911 2) _____ 3) _____

Voluntary Account Codes (Verified/Non-Verified)

Voluntary Account Codes are optional. They can be entered during a call and are used for tracking selected calls using SMDR call detail recording option.

If the system is set for Verified Account Codes, station users must enter a specific code when entering the Voluntary Account Code(s) or the code is not validated for the SMDR call report. This does not affect the call.

There are two ways to dial using a Voluntary Account Code

► To dial using the Account Code button

1. After accessing a CO line, press the **Account Code** button. LCD telephones prompt you to “ENTER ACCOUNT CODE NOW.”
2. Enter the account code digits. The LCD prompt disappears upon entry of the first account code digit. After the account code is entered, the time indicator is restored in the LCD.
3. If your station is set for Verified Account Codes, you hear confirmation tone when the code is valid. If the code is invalid, you hear two short tones.
4. Enter the Account Code. Your conversation is not interrupted.

► To enter an Account Code using access codes

Note It’s a good idea to warn the other party that you will be disconnected momentarily when you enter the access code. Once the code is entered, you will be connected again.

1. After accessing a CO line, press **CNF/TRN**. Once you press **CNF/TRN**, your call is interrupted; you and the other party cannot hear each other. You will hear feature dial tone.
2. Dial **#46**. LCD telephones prompt you to “ENTER ACCOUNT CODE NOW.”
3. Enter the account code digits. The prompt disappears upon entry of the first account code digit. After the account code is entered, the connection is restored and the LCD shows the time.

Automatic Busy Redial

This feature is not supported by the DKT2104-CT. It must be assigned to your DKT.

Automatic Callback

When you reach a busy station, you can set Automatic Callback to have the system monitor the busy extension and notify you when it becomes idle. Automatic Callback can also place you in queue for an available outside line, if you reach a line group in which all lines are busy. When a station or line becomes available, the system rings your telephone. Then when you answer, it automatically rings the intended destination. The amount of time the system will wait for an idle destination is set in system programming.

Automatic Callback is also known as “CO Line Queuing.”

► To set Automatic Callback

1. If you hear busy tone after dialing an outside line access code or a station number, press **Auto Callback** or **4**. Busy tone stops, followed by success tone, then busy tone resumes.
2. Hang up. You can make other calls while waiting.
3. When the called station or outside line becomes idle, your telephone rings with a fast LED.
 - If you called a busy station, the extension LED flashes green (incoming call) and the called number displays.
 - If you called a busy outside line, the extension LED flashes green (incoming call rate). The seized line’s number displays.
4. Answer within about three rings (five to 180 secs., set in programming) to prevent the callback from being cancelled. After you answer, you hear success tone, and the LED flashes green (in-use).

If you hear a busy tone after answering a callback, the called party is already on another call or the line has already been seized or has received an incoming call. Your request is not cancelled. You will be called again the next time a line becomes idle.

If you were attempting to make an outside call, the telephone number is automatically dialed, including the account code or override codes that were used.

► To cancel ACB

- Press **Auto Callback** or extension button + **#431**.

Auto Redial

This feature enables you to automatically redial the last number (outside or extension number) called by pressing **Redial**. **Redial** must be programmed as one of the four flexible buttons on the telephone.

1. Press your extension or **Line** button. Make sure that you press the same extension or **Line** button that you used to dial the telephone number that you wish to redial. You hear dial tone.
2. Press **Redial**. The last telephone number you dialed is automatically redialed.

Call Forward

System

System Call Forward (which is set in Programming) automatically directs calls to a predefined location, such as Voice Mail. See your CTX System Administrator to determine which type of Call Forward you have, as well as the Call Forward location.

Station

Station Call Forward enables you to assign Call Forward destinations for each extension on your phone. Each extension can be independently set for a different Call Forward feature.

Call Forward must be set prior to receiving the call.

The following calls to your station can be forwarded:

- Internal calls
- Auto Attendant calls
- Outside lines that ring only your station
- Transferred internal or incoming line calls

Call Forward Categories

You can set Call Forward for the following categories of calls. Within these categories, you can use five different types of Call Forward Settings.

- **Call Forward Any Call** – Forwards any call, whether an internal call or incoming line call.
- **Call Forward - Incoming Line** – Forward incoming line calls only.
- **Call Forward Any Call - Set for Another Station** – Enables you to forward all calls for another telephone within your telephone system.
- **Call Forward - Incoming Line Set for Another Station**– Enables you to set forwarding of incoming line calls for another telephone within your telephone system.
- **Call Forward System** – Forwards the calls to the destination preset for the entire telephone system, commonly voice mail.
- **Call Forward - External Location** – Forwards incoming line calls that ring directly to your extension to a destination outside the system.

You can change your forwarding destination from outside the system using the DISA feature. See your CTX System Administrator for DISA telephone numbers and security code access.

Call Forward Settings

- **Call Forward All Calls** – Forwards all calls immediately.
- **Call Forward Busy/Do Not Disturb** – Forwards calls immediately when your extension is busy or in Do Not Disturb (DND) mode.

In Tone-first systems with multiple lines, Call Forward Busy forwards calls only when all line appearances are in use. In Voice-first systems, Call Forward Busy forwards all calls any time your telephone is in use.
- **Call Forward - No Answer** – Forwards all calls to your station whenever you do not answer the call within a designated time (set by you when you enable the feature).
- **Call Forward Busy/Do Not Disturb/No Answer** – Forwards all calls to your station whenever you are busy, in the DND mode, or after ringing and you do not answer the call within a designated time (set by you when you enable the feature).

- **Call Forward Cancel** – Cancels the set Call Forward feature. Notice that each category of Call Forward has a different code for canceling.

Station Call Forward Procedures

The following table contains Call Forward Button sequences. You can do a Call Forward function by entering the button sequence as described.

Some Call Forward features require a Pass Code entry. Use the following procedure to change your Pass Code.

► **To change your Pass Code**

- Press Extension button + **#670** + ext. no. + old Pass Code (1~15 digits) + **#** + new Pass Code (1~15 digits) + **#**.

► **To use the Call Forward button sequence**

- Follow the instructions in the following table, shown under “Button Sequence.” Some features require additional input, such as:
 - **Destination** – If the destination is an outside number, press **#** after entering the destination. The CTX accepts destination numbers of up to 32 digits.
 - **Timer** – This is a two digit entry representing how long (8 to 160 seconds) your telephone should ring before forwarding the call. If you enter one digit, you must press **#** after entering the single digit.
 - **Pass Code** – A four-digit code established by system programming to prevent unauthorized changes. The code applies to the station to be forwarded; not to the station entering the code.

Note In the following table, (Tone) means that a confirmation tone will play at that point in the sequence.

Table 3 Call Forward Procedure

Feature	Button Sequence
Call Forward Any Call - Internal and Incoming Line Calls: Forwards any call, whether an internal call or incoming line call.	
All Calls	Extension button + #6011 (Tone) + Destination No. (Tone)
Busy	Extension button + #6021 (Tone) + Dest. No. (Tone)
No Answer	Extension button + #6031 (Tone) + Dest. No. (Tone) + Timer + #

Features

Call Forward

Table 3 Call Forward Procedure (continued)

Feature	Button Sequence
Busy No Answer	Extension button + #6041 + Dest. No. + Timer + #
Cancel	Extension button + #6051 (Tone)
Call Forward - Incoming Line Calls:	
Forward incoming line calls only.	
All Calls	Extension button + #6013 (Tone) + Dest. No. (Tone)
Busy	Extension button + #6023 (Tone) + Dest. No. (Tone)
No Answer	Extension button + #6033 + Dest. No. (Tone) + Timer (Tone) + #
Busy No Answer	Extension button + #6043 + Dest. No. (Tone) + Timer (Tone) + #
Cancel	Extension button + #6053 (Tone)
Call Forward Any Call - Set for Another Station:	
Enables you to forward all calls for another telephone within your telephone system.	
All Calls	Extension button + #6012 (Tone) + ext. no. + Pass Code (Tone) + # + Dest. No. + # (Tone)
Busy	Extension button + #6022 (Tone) + ext. no. + Pass Code (Tone) + # + Dest. No. + # (Tone)
No Answer	Extension button + #6032 (Tone) + ext. no. + Pass Code (Tone) + # + Dest. No. (Tone) + # + Timer + # (Tone)
Busy No Answer	Extension button + #6042 + ext. no. + Pass Code + # (Tone) + Dest. No. (Tone) + # Timer + # (Tone)
Cancel	Extension button + #6052 (Tone) + ext. no. + Pass Code + # (Tone)

Table 3 Call Forward Procedure (continued)

Feature	Button Sequence
Call Forward - Incoming Line Call - Set for Another Station:	
Enables you to set forwarding of incoming line calls for another telephone within your telephone system	
All Calls	Extension button + #6014 (Tone) + ext. no. + Pass Code + # (Tone) + Dest. No. (Tone) + #
Busy	Extension button + #6024 (Tone) + ext. no. + Pass Code + # (Tone) + Dest. No. (Tone) + #
No Answer	Extension button + #6034 (Tone) + ext. no. + Pass Code + # (Tone) + Dest. No. (Tone) + # + Timer + #
Busy No Answer	Extension button + #6044 (Tone) + ext. no. + Pass Code + # (Tone) + Dest. No. (Tone) + # + Timer + #
Cancel	Extension button + #6054 (Tone) + ext. no. + Pass Code + # (Tone)
Change Pass Code	Extension button + #670 (Tone) + ext. no. (Tone) + old Pass Code + # (Tone) + new Pass Code (Tone) + #
Call Forward - System:	
Forwards the calls to the destination preset for the entire telephone system, commonly voice mail.	
Activate	#620 (Tone)
Cancel	#621 (Tone)

Call Park Orbits

The Call Park feature enables you to hold a call temporarily in a location other than your telephone. These areas are called orbits. You or another telephone user can retrieve a parked call from its orbit by specifying the orbit number. You can specify one of 20 General Park Orbits (7000~7019) or a valid extension number within the system.

Once you have parked a call in an orbit, you can:

- Hang up and retrieve the parked call at a later time
- Originate another call
- Access a voice paging device to announce the parked call for pickup from another station

If you park a call and it is not retrieved, it will recall to the parking station and one of the following occurs:

- If your station is idle when the system Call Park recall timer expires, the parked call automatically recalls to your station.
- If your station is busy, the parked call camps on.

If you have an LCD telephone, you can let the system automatically select an available orbit number which displays on your LCD.

► To park a call

1. While on a call, press **Park in Orbit**
...or **CNF/TRN + #33**. The LED flashes green (consultation-hold).
2. Specify the Park Orbit using one of the following:
 - Press ***** and the system automatically selects a General Park Orbit between **7000~7019**. The chosen orbit appears on the LCD.
 - Enter a valid extension.
 - Press **#** and the system automatically selects your extension as the orbit.
3. Hang up. The caller's extension or line number and the orbit number are shown. If the parked call is not retrieved within a specified time, the call rings back to your phone. When a parked call recalls your phone, the LCD shows the line or extension that is recalling and the orbit number.

► **To retrieve a parked call**

1. Press **Park in Orbit...** or your extension button + **#32**.
2. Enter the Orbit Number where the call is parked or **#** for the extension from which you are calling. You cannot use ***** to retrieve a parked call. The extension LED flashes at the in-use rate when the call is retrieved. Call Pickup

You can pick up a call that is ringing another station's extension, a call placed on hold at another station and other types of calls. When you pick up an internal call, the calling station and the called station displays on your LCD.

Group Pickup

Stations can be assigned in system programming to Pickup Groups. As many as 32 groups can be created to enable you to easily pick up incoming (new or transferred) or internal calls that are ringing stations that are in your group or in other groups. This feature does not pick up held calls. You may belong to more than one group. See your CTX System Administrator for group assignments.

Page/Internal Call Pickup

This feature picks up Internal (station to station), Group Page, and All Call Page calls. If these types of calls occur at the same time, the pickup priority is station-to-station and then Page calls in the order of occurrence. In some systems, this feature can be applied to pick up All Call Page exclusively.

► **To perform Call Pickup**

1. Press an extension button.
2. Enter a code from the following table.

Features

Call Park Orbits

Table 4 Call Pickup Feature Codes

For Incoming Calls:	Dialing	Description
Group	#5#34	Picks up a call ringing to a member of your pickup group.
Directed Extension	#5#5 + Primary Ext. No.	Picks up a call ringing on any line appearance of the telephone specified by its Primary extension number.
Directed Group	#5#32 + Group No.	Picks up a call ringing to a terminal in the specified Pickup Group.
Directory Number	#5#22 + Ext. No.	Picks up a call ringing to the specified extension number only. Other lines ringing on the same phone are unaffected.
Any External Call	#5#9	Picks up any incoming outside line call.
For Calls On Hold:	Dialing	Description
Local Retrieve	#5#71	Picks up a call held on the telephone from which it is dialed.
Remote Retrieve	#5#72 + Primary Ext. No.	Retrieves a call held on the telephone specified extension number.
Outside Line Retrieve	#5#73 + Outside Line No. (1~128)	Picks up a call held on the specified CO line regardless of the telephone placing the call on hold. Must enter three digits (e.g., 007).
Directed Extension Retrieve	#5#74 + Ext. No.	Picks up a call held on the specified extension number, regardless of the instrument(s) on which it appears.

Notes

- The Primary extension number is the directory number by which the phone set is defined. Other, non-primary extension numbers may also appear on the phone. By convention, the Primary extension number is assigned to the first button on a multi-button telephone.
- If more than one call is on hold, the call on the telephone's lowest button number is picked up.
- Ringing calls are picked up over held calls as a priority.

Call Waiting

Call Waiting places an incoming call in queue and alerts you with a warning tone. The [DN] or Line LED flashes at the on-hold rate.

1. If you are talking, press **HOLD**

...or the flashing [DN]. The call you are on is placed on hold and you are connected to the waiting call. The [DN] or Line LED lights steady.

...or **Line** if your telephone has the Auto Hold feature. See your System Administrator to find out if you have Auto Hold.

...or the ringing [DN] or **Line**. This disconnects the current call and then connects you to the transferred call. The [DN] or Line LED remains steady.

...or **talk**. The existing call is disconnected. The camped-on line rings your telephone and the Line LED flashes at the incoming call rate.

2. Press a [DN], then **Line**

...or **talk** again.

Direct Station Selection Buttons (Hotline)

This optional feature enables you to use a **DSS** button to connect directly to another station's line extension. The DSS LED shows the status (idle/busy) of the station and/or the station's primary extension. For example, a station's DSS button LED shows busy (light steady red) when the station is:

- busy on a call on any button
- idle but all appearances of the station's extension are in use by other stations.

When the station is in DND, the LED flashes red.

► To connect directly to another station's extension

1. When connected to a line or another station, press **DSS**.

The original party is put on-hold. You can call a station even if the DSS LED shows busy (steady red).

2. Announce the call...or transfer the call by hanging up or pressing **Release**.

Note You can transfer the call to an idle or busy station.

Do Not Disturb

If your station is in Do Not Disturb (DND) mode, internal, external and transferred calls do not ring your station and Off-hook Call Announce calls are denied. You can continue to make calls while in the DND mode. When originating a call in DND mode, you will hear a short burst of interrupted dial tone followed by continuous dial tone. You can start dialing at any time during either tone.

If you put your Primary extension into DND mode, all calls to that telephone are rejected. If your extension is set for Call Forward-Busy or Call Forward-Busy/No Answer, the call is redirected to the forwarding destination immediately.

If you put an extension other than the Primary extension into DND, only calls to that extension on your phone will be blocked. Appearances of that extension on other telephones continue to ring.

► To activate DND on your Primary extension

- Press **Do Not Disturb** or **#6091** (hear Success Tone). The LED lights steady red and DND mode is activated for the entire station.

► To activate DND on a non-Primary extension

- Press the desired extension appearance and **Do Not Disturb** or **#6091** (hear Success Tone). The LED lights steady red and DND mode is activated for that extension on your phone.

► To deactivate DND

- Press **Do Not Disturb** or **#6092** (hear Success Tone). The LED lights goes out and DND mode is de-activated.

Setting DND for Another Extension

► To activate DND for another extension

- Enter **#6191** (hear Entry Tone) + the Primary extension of the remote extension + the pass code + **#** (hear Success Tone). This sets DND as if activated by the Primary extension on the target telephone.

➤ **To deactivate DND for another extension**

- Enter **#6192** (hear Entry Tone) + the Primary extension of the remote extension + the pass code + **#** (hear Success Tone). This removes DND from the target telephone.

➤ **To change your DND Pass Code**

- Enter **#670** (hear Entry Tone) + ext. no. (hear Entry Tone) + old pass code + **#** (hear Entry Tone) + new pass code + **#** (hear Success Tone).

If you activate DND while a call is ringing, the ringing stops. The LED continues to flash on your telephone and ring on other appearances.

Door Lock(s)

Your telephone may have **Unlock Door** button(s), which enable you to unlock a door. Each **Unlock Door** button is programmed for a specific lock. Check with your CTX System Administrator to find out the names and locations of your system's door phones and record them below.

Door Lock No.	Location
0	
1	
2	
3	
4	
5	

Door Lock No.	Location
6	
7	
8	
9	
10	

➤ **To unlock a door**

- Press the specific **Unlock Door** button or **#12** + the Door Lock Number (see above table).

The door unlocks for 3~30 seconds (set in system programming). The Unlock Door LED is lit while the door is unlocked.

Features

Door Phone(s)

Door Phone(s)

Door phones can be used to call telephones selected in system programming. When a door phone calls, you hear a distinctive ringing tone, one or five times (set in system programming). You can also call a door phone and monitor the surrounding area.

The number of possible door phones varies by Strata CTX system, with up to 24 as the maximum for larger systems.

LCD telephones display the door phone name ID when calls are made to or from door phones. Check with your CTX System Administrator to find out the names and locations of your system's door phones and record them below.

Door Phone	Name/Location

Door Phone	Name/Location

➤ To answer a door phone call

- Lift the handset while the door phone is still ringing. The extension LED flashes green (in-use) and you are connected to the door phone.

...or to pick up door phone calls ringing someone else's phone, press extension + **#5#5** + directory number.

► **To call/monitor a door phone**

1. With the handset off-hook, press a extension. You hear dial tone and the LED flashes green (in-use).
2. Press **#15** + extension for the door location. A two-way talk-path exists between your telephone and the called door phone. You can audibly monitor the area around the door phone.

► **To call from a door phone**

1. Press the door phone button and then release it. You hear a distinctive ringing tone—one or five times (set in system programming).
2. When answered, speak at a normal voice level in the direction of the door phone.

Emergency Ringdown

If a station remains off-hook for a programmable period, it can be automatically treated as an Emergency Call and directed to an emergency destination. The station may have partially dialed a number or have dialed no digits at all. Each station is programmed with its specific emergency ringdown destination.

A station number or a group pilot number can be specified as an emergency ringdown destination. In a private network, the station or pilot number must be in the same network node. Remote emergency destination and door phones are not permitted.

Held Calls

Calls on hold can be released automatically if the held party hangs up and the network provides a hold-release signal.

Important! *The DKT2104-CT does not support Exclusive Hold.*

Placing Line Appearances or [DN] Calls on Hold

- Press **HOLD**.

The Line or [DN] LED flashes green at the on-hold rate.

You hear recall tone when your station is idle (or two times only when busy) if you do not retrieve the held call before “Hold the recall” time set in system programming expires.

Retrieving Held Calls

- Press **Line** or the [DN] that is on hold.

The Line or [DN] LED flashes at the on-hold rate.

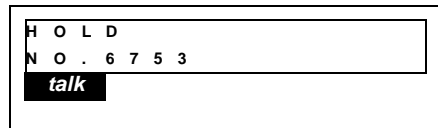

Using Automatic Hold

Automatic Hold enables you to place a call on hold by pressing another **Line** or [DN]. You do not have to press **HOLD**. You can also switch between a new and the original call without having to press **HOLD**. Automatic Hold is assigned on a station-by-station basis in system programming.

- Press another **Line** or [DN] to receive or originate a new call, while on one call.

The original Line or [DN] LED flashes at the on-hold rate and the original call is placed on hold.

The LED of the new call lights steady and the new line is accessed.

Switching Between Calls

- Press **Line** or [DN] of the held call.

The Line or [DN] LED just placed on hold flashes at the on-hold rate, and the LED of the Line just accessed lights steady.

ISDN Outgoing Calling

This feature enables calling over Integrated Services Digital Network (ISDN) trunks, provided that you are connected to a Strata CTX and that you subscribe to ISDN lines. ISDN trunks offer faster call connection setup and more connection circuits.

An ISDN call is initiated automatically with a timer or with a start sequence. The method depends on your system's programming. See your System Administrator to determine the method.

1. Access an outside CO line
2. Dial the number.
3. Press **Start**.

The dialed digits are not sent until you press this button or until the timer expires.

Subaddress

Subaddress digits can be required for dialing another department or sending a call to a printer.

1. Access an outside CO line.
2. Enter the number.
3. Press **Sub**. Sub informs the system that the digits following are the subaddress.
4. Enter the subaddress.
5. Press **Start**. The dialed digits are not sent until you press this button or until the timer expires.

Message Waiting

Use your **Msg** LED/button and LCD to see/retrieve message(s).

An extension can receive up to four simultaneous Message Waiting indications and LCD messages. One message is reserved for the Message Center.

Your phone can be programmed to have up to four additional (flexible) Message Waiting buttons/LEDs. Check with your System Administrator to see if these buttons have been programmed on your phone. If so, substitute them when the **Msg** button/LED is mentioned in the following steps.

Responding to a Lit Msg LED

1. Press **Msg**, then lift the handset. Your phone rings the extension or voice mail device that sent the indication. The LED continues to flash red.
2. After answering the message(s), place the handset back on-hook.
3. If the Msg LED continues to flash, you have more messages; repeat Steps 1~3 above to retrieve them. Voice mail devices turn off the LED/LCD indications after a short delay, after you checked all messages.
4. To manually turn off your Msg LED, press your extension button, then press **#409**. Do this step for each message received.

Off-hook Call Announce

Off-hook Call Announce (OCA) allows you to complete a call to a *busy* digital telephone. Your telephone must be programmed to either announce automatically or to announce after you press a button on your dial pad. The destination telephone must be programmed to accept an OCA. The announcement may be delivered over the handset or the speaker.

Handset OCA can operate on any digital telephone. Speaker OCA requires the addition of a special circuit board inside the DKT speakerphone.

► To make an OCA call

- **Manual** – Dial an extension. When you hear busy tone, press **5** and, after one long tone, you can talk through the speaker of the destination telephone. The person you are calling has answering options described below.
- **Automatic** – If your telephone and the extension you are calling have been programmed for Automatic OCA, you can talk through the speaker of the destination telephone without hearing the busy tone and without dialing **5**.

Override Calls

The available override features are:

Busy Override

Ring Over Busy Override enables you to send a muted ring tone to a busy station to indicate a call is waiting. The Busy Override (BOV) muted ring can be programmed for each station to be two muted rings only or continued muted rings until the call is answered. This option applies to the station receiving the muted ring. The muted ring can be sent to the telephone speaker or to the telephone handset/headset and speaker.

► To use Busy Override

- After reaching a busy station, press **2**. A muted tone is heard at the busy station, indicating that a call is waiting. The station number displays.

Do Not Disturb Override

Do Not Disturb (DND) Override lets you send a call waiting tone or ringing to a station in DND mode to indicate that a call is coming in. Your telephone may be programmed to block DND Override from other telephones. Your station's LCD shows the station you have called is in the DND mode.

OCA is possible to DND stations from stations that are programmed for DND Override.

► To use DND Override

- After reaching a station in DND mode, press **2**. A tone signal is heard at the DND station, indicating a call is coming in. On your station, the LCD shows the station number you have overridden.

Your LCD displays **DND OVR DENY**, if the station you called denies DND Override.

Executive Override

Executive Override enables you to enter an established conversation. Your telephone can also be programmed to block Executive Override from other telephones.

► To perform Executive Override

- After reaching a busy station, press **3**

...or, if you have an LCD telephone, use the **OVRD** Soft Key.

You enter a conference with the busy station and the party to whom he was talking. The called parties may hear an optional tone signal prior to your entering the conversation.

Your LCD displays **EXEC OVR DENY**, if the station you called denies Executive Override. If you do not have Override privileges, you will camp on.

Privacy Override

This feature enables you to enter an established call on a line you share with another telephone. Up to two station users can enter an existing CO line-to-station call (i.e., up to three stations can be connected to a CO line). You can also use this feature if the station that is already connected to the CO line is in the Privacy Release mode.

Station users with **Privacy Release** can allow stations with the shared button appearance to enter their conversations, even if the station entering the conversation is not programmed for Privacy Override. (see “[Privacy](#)” on [page 50](#).)

Paging

Station users can make page announcements to telephones and external speakers. Check with your CTX System Administrator to find out the zone numbers for various paging groups.

► To make a Page Announcement to a phones or external speakers

1. Lift the handset, press extension and enter a paging access code.
2. Make your announcement, then hang up.

► **To make a Group Page**

- Press **Group Page** and enter the Group number (01~16)
...or press extension + **#31** and enter the zone number.

Answering a Page

- To answer a Group Page, lift the handset off-hook, press extension + **#5#35** and enter the Group number.
- To answer an External Group Page, lift the handset off-hook, press extension + **#5#36** and enter the Group number.

All Call Page

You can make an All Call Page to telephones assigned to the “All Call Page Group.” Stations are assigned to the “All Call Page Group” in system programming.

► **To make an All Call Page**

1. With the handset off-hook, press **All Call Page**...or extension + **#30**. This pages all phones in the All Call Page Group but, depending on system programming, you may or may not page external speakers.
2. Make your announcement then hang up.

► **To answer an All Call Page**

- Lift the handset off-hook, press extension + **#5#35**.

Emergency Page

An Emergency Page overrides Group Pages or All Call Pages to telephone and external paging devices.

- To make an Emergency Page, lift the handset off-hook, press extension + **#37**.
- To make an Emergency Page to a group, lift the handset off-hook, press extension + **#38** and enter the Zone number.

Privacy

Privacy controls the ability of more than one person to use the same extension or CO line at the same time. Privacy applies to multiple appearances of extensions, Phantom extensions, outside Lines and outside Line Group buttons. The application of Privacy to individual telephones is controlled in system programming.

By default, the system is private. If you are in a conversation, another telephone with an appearance of the line on which you are talking cannot intrude unless that telephone has been programmed for Privacy Override. In that event, the other telephone may enter and leave the conversation at will. If all users are provided with Privacy Release in Class of Service, the system will function as non-private.

Your phone may be equipped with a **Privacy Release** and/or a **Privacy on Line** button. On a normally private telephone, **Privacy Release** allows other appearances of your line to join the conversation. On a normally non-private telephone, **Privacy on Line** allows you to exclude others. The Privacy condition may be toggled at any time during a conversation. At the end of the conversation, the line's privacy condition returns to its original state.

➤ To use Privacy Release

➤ While on a CO line call, press **Privacy Release**. The LED lights red. The outside line flashes at all appearances. When another station user enters the outside line call by pressing a common outside **Line**, the Privacy Release LED turns Off. To add a third station, press **Privacy Release** again; the process repeats.

➤ To set/cancel Privacy

➤ Press **Privacy on Line** to set privacy. The LED lights steady red. Others are blocked from entering your outside line calls when they press a common **Line** button

...or press **Privacy on Line** again to cancel the feature. The LED turns Off.

Redial

Use this button to redial the last number dialed from your phone.

➤ To redial the last number, press **Redial** or ***0**.

Release and Answer

This feature enables you to automatically disconnect or transfer an active call and answer a new call with the push of a button, instead of with the handset.

Note Your telephone must be programmed with **Release and Ans**.

- Press the **Release and Ans**. The Line or extension LED flashes to indicate a new incoming call while you are connected to the existing call. You hear a muted, Busy Override or Camp-on-busy tone. The original call is released and you can answer the new call.

...or **CNF/TRN** and dial a “transfer-to” destination. Then, press **Release and Ans**. This transfers the original call and answers the new call.

...or **DSS** of a “transfer-to” destination, then press **Release and Ans**. This transfers the original call and answers the new call.

Speed Dial

Speed Dial enables you to dial a sequence of up to 32 digits with a shorter code. Dial sequences can include telephone numbers, authorization codes, passwords feature activation codes and pauses. Speed Dial may be used to originate a call or invoked after a call is established.

There are two types of Speed Dial.

- **Station** – Your CTX System Administrator allocates a block of up to 100 personal speed dial numbers in increments of 10 per phone. You have exclusive use of them.
- **System** – All telephones in your system can share a list of up to 800 System Speed Dial numbers under the exclusive control of the CTX System Administrator. In some cases, System Speed Dial will allow you to reach numbers that you would not be allowed to dial directly from your telephone.

Make a Call Using Speed Dial

There are three ways to begin a Speed Dial Call.

- Dial *
- ...or press **Spdial**

Then, dial the Station or System Speed Dial Number. Station Speed Dial numbers occupy numbers 100~199. System Speed Dial numbers occupy numbers 200~999.

Tone/Pulse Dialing

With some older Central Offices, you may have to make calls on outside lines programmed for rotary dial pulses. This feature enables you, while on these lines, to switch to tone dial to access remote equipment (such as an answering machine) requiring touchtones.

Note With ISDN calls, when **Tone Dial Select** is pressed, all of the digits entered after that point will be sent with touchtones.

► To change Tone Dialing

1. Access an outside line.
2. Dial a telephone number.
3. While on the call, press **Tone Dial Select**. Although the outside line is programmed for rotary dial pulses, access the outside line and dial the telephone number like any other call described in this user guide.

The Tone LED lights steady red and you are able to send touchtones with your dial pad. The feature is cancelled when the call is completed.

Voice Mail - Direct Transfer

The Strata CTX enables you to transfer a call directly to a voice mailbox without first ringing that person's telephone.

► To transfer a call directly to Voice Mail (VM)

1. While on a call, press **CNF/TRN**. You hear feature dial tone.
2. Press **Direct Transfer to VM** or enter **#407**. You hear entry tone.
3. Enter the VM mailbox number (usually the same as the extension number), then press **#**. The call transfers immediately and your extension becomes idle.

Appendix – Feature Access Codes

A

This chapter contains Feature Access Codes which are entered as a sequence on your telephone to use a particular feature.

Also, the Call Forward Feature Access Codes sometimes have special requirements for entering a destination and a timer. Refer to [“To use the Call Forward button sequence”](#) on [page 33](#) for more details on these entries.

Table 5 Feature Access Codes

Feature	Feature Access Code Sequences
Account Code	CNF/TRN + #46 + Account code digits
Attendant Console	0
Automatic Busy Redial - On	#441
Automatic Busy Redial - Off	#442
Automatic Callback Cancel	#431
Background Music	
Phone Speaker On	Ext. button + #490 + source number + #
Phone Speaker Off	Ext. button + #491
External Speaker On	Ext. button + #492 + source number + #
External Speaker Off	Ext. button + #493

Appendix – Feature Access Codes

Voice Mail - Direct Transfer

Table 5 Feature Access Codes (continued)

Feature	Feature Access Code Sequences
Call Forward - Any Calls (Internal and External)	
All Call	Ext. button + #6011 + Dest. No
Busy	Ext. button + #6021 + Dest. No.
No Answer	Ext. button + #6031 + Dest. No. + Timer + #
Busy No Answer	Ext. button + #6041 + Dest. No. + Timer + #
Cancel	Ext. button + #6051
Call Forward - External (Outside) Calls	
All Call	Ext. button + #6013 + Dest. No.
Busy	Ext. button + #6023 + Dest. No.
No Answer	Ext. button + #6033 + Dest. No. + Timer + #
Busy No Answer	Ext. button + #6043 + Dest. No. + Timer + #
Cancel	Ext. button + #6053
Call Forward - Remote Activation	
All Call	Ext. button + #6012 + ext. no. + Pass Code + # + Dest. No. + #
Busy	Ext. button + #6022 + ext. no. + Pass Code + # + Dest. No. + #
No Answer	Ext. button + #6032 + ext. no. + Pass Code + # + Dest. No. + # + Timer + #
Busy No Answer	Ext. button + #6042 + ext. no. + Pass Code + # + Dest. No. + # + Timer + #
Cancel	Ext. button + #6052 + ext. no. + Pass Code + #
Call Forward - External Calls - Remote Activation	
All Calls	Ext. button + #6014 + ext. no. + Pass Code + # + Dest. No. + #
Busy	Ext. button + #6024 + ext. no. + Pass Code + # + Dest. No. + #
No Answer	Ext. button + #6034 + Dest. No. + # + ext. no. + Pass Code + # + Dest. No. + # + Timer + #
Busy No Answer	Ext. button + #6044 + Dest. No. + # + ext. no. + Pass Code + # + Dest. No. + # + Timer + #
Cancel	Ext. button + #6054 + ext. no. + Pass Code + #
Change Pass Code	Ext. button + #670 + ext. no. + old Pass Code + # + new Pass Code + #
Call Forward - System	
Activate	#620
Cancel	#621

Table 5 Feature Access Codes (continued)

Feature	Feature Access Code Sequences
Call Park	
Activate	CNF/TRN + #33 + Orbit Number
Retrieve	Ext. button + #32 + Orbit Number
System Orbits	7000~7019
Call Pickup	
Incoming - Group Pickup	Ext. button + #5#34
Incoming - Directed Terminal Pickup	Ext. button + #5#5 + Ext. Number to be picked up
Incoming - Directed Group Pickup	Ext. button + #5#32 + Group Number to be picked up
Incoming - Directed Extension Pickup	Ext. button + #5#22 + Ext. Number
On hold - Local Retrieve	Ext. button + #5#71
On hold - Remote Retrieve	Ext. button + #5#72 + Remote Ext. No.
On hold - Outside line Retrieve	Ext. button + #5#73 + Line on hold
On hold - Directed Extension Retrieve	Ext. button + #5#74 + Ext. No. on hold
Incoming - Any External Call	Ext. button + #5#9
Conferencing - Three Way	#494
Dialing	
Dial *	441
Dial #	440
DISA Security Code - Change	#658 + old Security Code (1~15 digits) + # + new Security Code (1~15 digits) + #
Do Not Disturb	
Local - On	#6091
Local - Off	#6092
Remote - On	#6191 + ext. no. + Pass Code Number + #
Remote - Off	#6192 + ext. no. + Pass Code Number + #
Door Lock Control	#12 + Door Lock Number
Door Phone Calling	#15 + Door Phone No.
Emergency Call	#911
Flash - Short	#450
Flash - Long	#451

Appendix – Feature Access Codes

Voice Mail - Direct Transfer

Table 5 Feature Access Codes (continued)

Feature	Feature Access Code Sequences
LCD Language (Change)	#495 + Language No.
LCR (Outgoing Call)	9
Message Waiting (MW)	
Release a received MW	#409
Retrieve a received MW	#408
Activate MW at another Station without Ringing	#63 + Ext. no.
Cancel MW at another Station without Ringing	#64 + Ext. no.
Messaging - Advisory	
Advisory Message - Activation	#411 + Message No.
Advisory Message Cancellation	#412
Private Network Access Code	8 + Private Network No.
Night Ring Answer	#5#39
Off-hook Call Announce (Manual Mode)	Voice First: 2 ; Tone First: 1, 21, or 12
Override	
Busy, Do Not Disturb	2
Executive	3
Paging	
Page All Groups	#30
Page Individual Groups	#31 + Group Number
Emergency Page - Individual Group	#38 + Group Number
Emergency Page - All Groups	#37
Answer Page - All Groups	#5#35
Answer for External Group Page	#5#36 + Zone Number
Repeat Last Number Dialed	* 0

Table 5 Feature Access Codes (continued)

Feature	Feature Access Code Sequences
Speed Dial Register	#66
Station (00~99)	* 1 + Index Number (00~99)
System	* 2 + Index Number (000~099)
	* 3 + Index Number (100~199)
	* 4 + Index Number (200~299)
	* 5 + Index Number (300~399)
	* 6 + Index Number (400~499)
	* 7 + Index Number (500~599)
	* 8 + Index Number (600~699)
	* 9 + Index Number (700~799)
Start Application	#18
Substitution of Dial “#”	441
Substitution of Dial “*”	441
Travelling Class Override	
Enter Code	#471
Change Code	#69 + Index Number + old Code + # + new Code + #
User Programming Mode	#9876
Voice Mail (VM)	
Direct Transfer to Voice Mail	#407 + Ext. Number
Volume Control - Beep	#6101
Volume Control - Ringing	#6102

Appendix – Feature Access Codes

Voice Mail - Direct Transfer

Appendix – Troubleshooting and Specifications

B

This appendix covers these topics:

- Troubleshooting
- Range and performance
- Simultaneous conversation channels
- Radio interference
- Specifications

Troubleshooting

If your cordless telephone is not performing to your expectations, try the suggestions in [Table 6](#). If you are still unable to resolve the problem, contact your telephone System Administrator.

Important! *Do not attempt to service this unit yourself. All service must be done by qualified service personnel.*

Appendix – Troubleshooting and Specifications

Troubleshooting

Table 6 Troubleshooting Suggestions

Condition	Suggestion
CHARGE LED does not light when handset is placed on Base Unit.	<p>Make sure the AC adapter is plugged into the Charger Unit and wall outlet. If the AC adapter is plugged into a wall outlet with a switch, make sure the switch is turned on.</p> <p>Make sure the handset is properly seated in the Charger Unit.</p> <p>Make sure the Sealed Lead-acid battery is properly seated in the handset.</p> <p>Make sure that the charging contacts on the handset and Charger Unit are clean.</p>
Conversation is interrupted frequently.	<p>Make sure that the Base Unit antenna is fully vertical.</p> <p>Move closer to the Base Unit.</p>
Echo during conversation.	<p>Depending on the environment from which you are calling, such as a noisy area, a caller using a DKT may experience echo if the volume control of the handset is set at 10 or higher. You can lower the volume using ▼ or contact your authorized dealer for handset software upgrade.</p>
No dial tone.	<p>Move closer to the Base Unit.</p>
Cannot configure the handset.	<p>Check all telephone cables and lines for good connections.</p> <p>Make sure the AC adapter is plugged into the Base Unit and wall outlet.</p>
Handset does not ring.	<p>The Sealed Lead-acid battery could be weak. Charge the battery for 8-10 hours.</p> <p>Check the ringer - it could be turned off.</p> <p>Make sure the Base Unit antenna is fully vertical.</p> <p>Move closer to the Base Unit.</p>
Tone noise.	<p>Move the handset to the right of the DKT.</p>
Other.	<p>Contact your System Administrator.</p>

Range and Performance

The cordless digital telephone operates up to 1.1 miles from its base in a completely unrestricted test environment. Typically, ranges of 300 to 400 feet are possible, depending on the building structure in which the it's used. For optimum range and performance from your handset, try the following:

- Place the Base Units at least three to six feet away from the DKT; three feet from metal structures; and six feet from computers, fax machines or other electronic equipment.
- Use an AC outlet not associated with computer or electromagnetic equipment.
- Wherever possible, put the Base Unit in the middle of the coverage area.
- Mount the Base Unit high in the room for maximum range.
- Put 3 or less handsets 12 feet apart.
- Put 4 to 10 cordless telephones 20 feet apart.

Simultaneous Conversation Channels

The cordless handset has 30 operating channels available. A common misconception is that this limits a customer to 30 handsets. This is not the case. Each handset can operate on any of the 30 channels because each one selects an available channel within its range. In a given range, 30 simultaneous calls can be made.

Another factor is the distribution of the telephones in a facility. If your handsets are disbursed throughout a facility, there should not be contention for all channels. If there are more than 30 in one area and 30 users are using their handsets, the 31st user would not be able to get dial tone.

Radio Interference

Radio interference occasionally interrupts conversations, which does not mean that your unit is defective. Move to a different location while you are talking. If the interference continues, move the Base Unit. If there is still interference, contact your System Administrator.

Specifications

For frequencies, power requirements, weight and size specifications, see [Table 7](#).

Table 7 Specifications

General	
Frequency Control	Frequency Synthesizer
Modulation	FM
Operating Temperature	-10° to 50° C
Base Unit	
Receive/Transmit Frequency	905–925 MHz (30 channels)
Power Requirements	10VDC from supplied AC adapter
Size	Width – 5.0 inches Depth – 7.5 inches Height – 3.7 inches
Weight	Approximately 1 lb., 5 oz.
Handset	
Receive/Transmit Frequency	905–925 MHz (30 channels)
Power Requirements	9VDC from supplied AC adapter Rechargeable Sealed Lead Acid battery (2)
Size	Width – 2.125 inches Depth – 8.75 inches Height – 6.5 inches with antenna
Weight	Approximately 10.5 oz. with battery
Battery	Capacity – 500 mAh, 4V Talk Mode – 5 hours (typical) Standby Mode – 40 hours (typical)

Index

A

- access codes, 53
- account code, 53
 - calls, 28
 - forced account codes (verified/non-verified), 28
- account code calls, 28
- advisory messaging, 56
- all call page, 49
- answering
 - calls, 23
- attendant console, 53
- automatic
 - busy redial, 53
 - callback, 31
 - callback cancel, 53
 - hold, 44
- automatic busy redial, 29
- automatic callback, 30

B

- background music (BGM), 53
- battery, 4
 - charging extra packs, 7
 - extending life, 7
 - removing and charging, 13
- busy override, 47

C

- call
 - hold, 44
 - park orbits, 36
- call forward, 31
 - access codes, 54
 - any call, 32
 - pass code, 33
 - station, 31
 - system, 31, 54
- call park, 55
 - orbits, 36
- call pickup, 37, 55
- call transfer with camp-on, 23
- change pass code, 33
- conference
 - calls, 25
 - voice mail, 26
- conferencing, 55
- configuration, 15

D

- dial
 - internal calls, 22
- direct station selection buttons (hotline), 39
- DISA
 - security code, 55

do not disturb, [40, 55](#)
 override, [47](#)

door lock, [41](#)
 control, [55](#)

door phone, [42](#)
 calling, [55](#)

E

emergency
 call, [55](#)
 page, [49](#)
emergency calls to the attendant console, [22](#)
executive override, [48](#)

F

feature access codes, [53](#)
features, [7](#)
flash, [55](#)
forced account codes (verified/non-verified), [28](#)

G

group pickup, [37](#)

H

handset, [17, 20](#)
 volume level, [17](#)

I

installation, [7](#)
installing optional headset, [14](#)
ISDN
 buttons, [22, 52](#)

L

language changes, [56](#)
LCD

low battery indicator, [7](#)
name/number display, [45](#)

LCR

dialing out, [56](#)

line

access, [20](#)
buttons, [20](#)

M

memory, [20](#)
message waiting, [39, 45, 56](#)
messaging, [45](#)
 advisory, [56](#)
Msg button/LED, [46](#)

N

name/number display, [45](#)
narrow band technology, [2](#)
night ring answer, [56](#)

O

off-hook call announce (OCA), [46, 56](#)
outside line access, [20](#)
override
 access codes, [56](#)
 busy, [47](#)
 do not disturb, [47](#)
 executive, [48](#)
 privacy, [48](#)
 travelling class, [57](#)
override calls, [47](#)

P

paging, [37](#)
 access codes, [56](#)
pass code, [33](#)
pick up group calls, [37](#)

pooled line group, 20
privacy, 50
 on-line, 48
 override, 48
private network access, 56

R

radio interference, 61
range, 61
release and answer, 51
repeat last number dialed, 56
ringer volume level, 19

S

simultaneous conversation channels, 61
specifications, 62
speed dial, 51
 access codes, 57
start (ISDN button), 22, 45
start application, 57
sub (subaddress ISDN button), 45

T

tone/pulse dialing, 52
transfer
 a call, 23
travelling class override, 57
two (tandem) CO line connection, 26

U

user programming, 57

V

voice mail
 access codes, 57
 conference, 26
 direct transfer, 52
volume control, 57
voluntary account codes (verified/non-verified), 29